

KRUMPS' PROJECTS

**MJOLNIR
BUILD MANUAL**

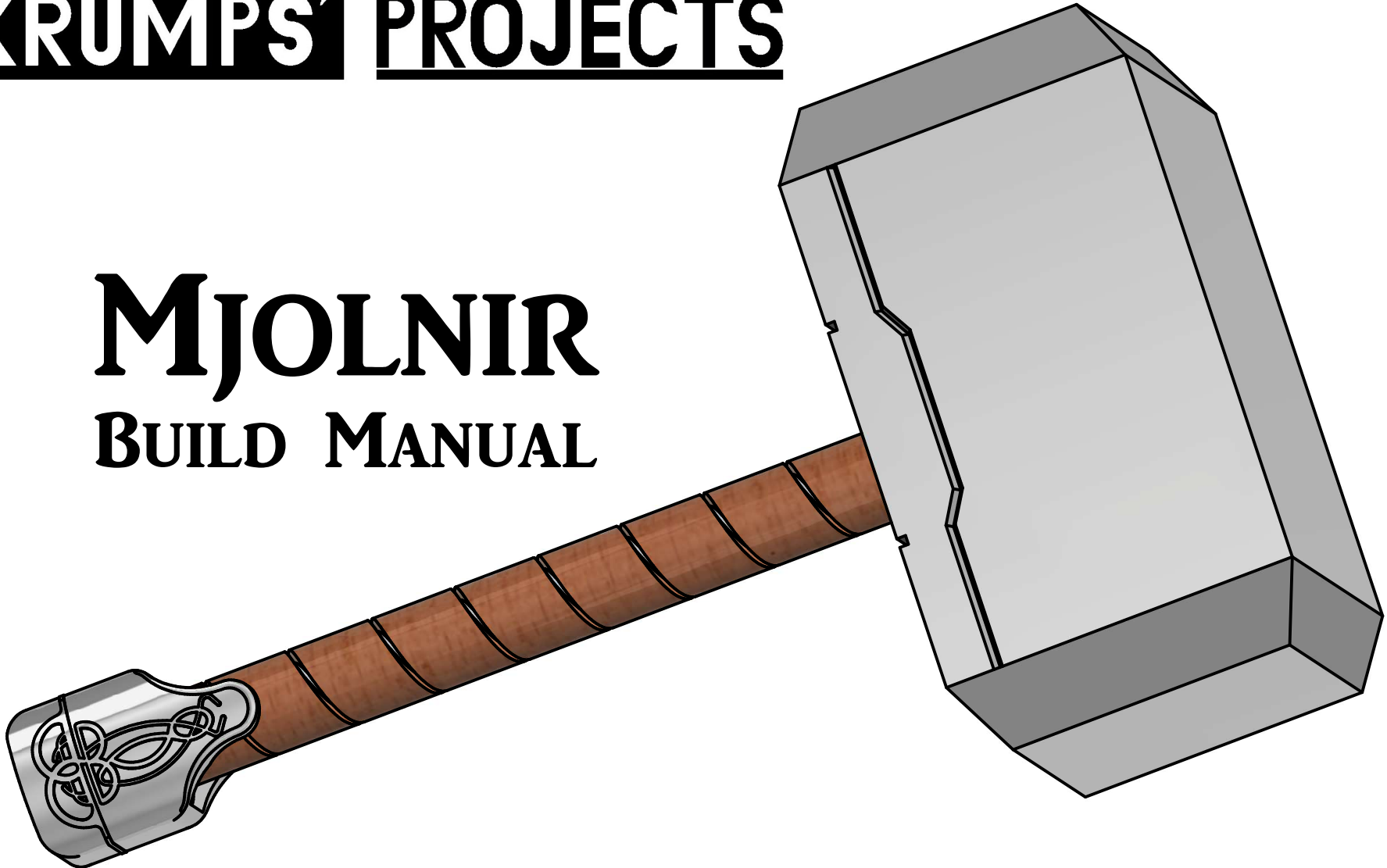

ARE YOU WORTHY

2

1

B

B

A

A

A

A

2

1



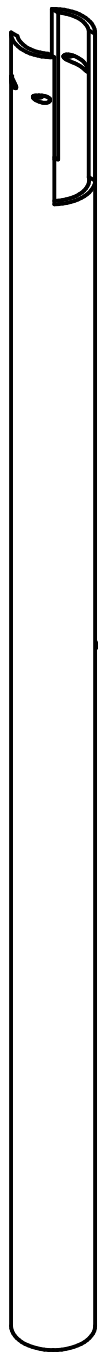

2



1

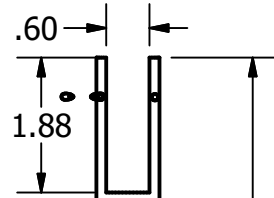

16.50

4" exposed for attachment to hammer head.

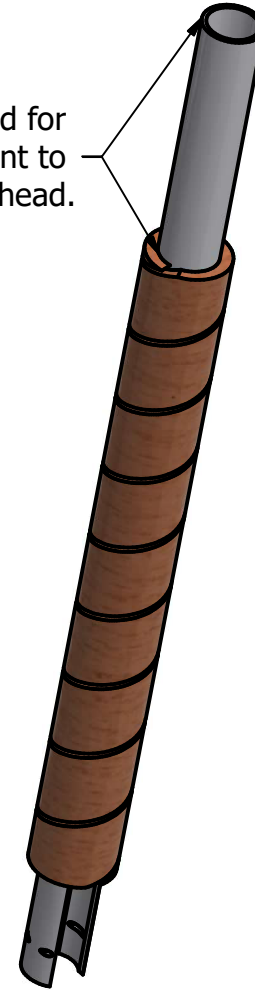

B

B



A

A

2



1

KRUMPS' PROJECTS

2



1

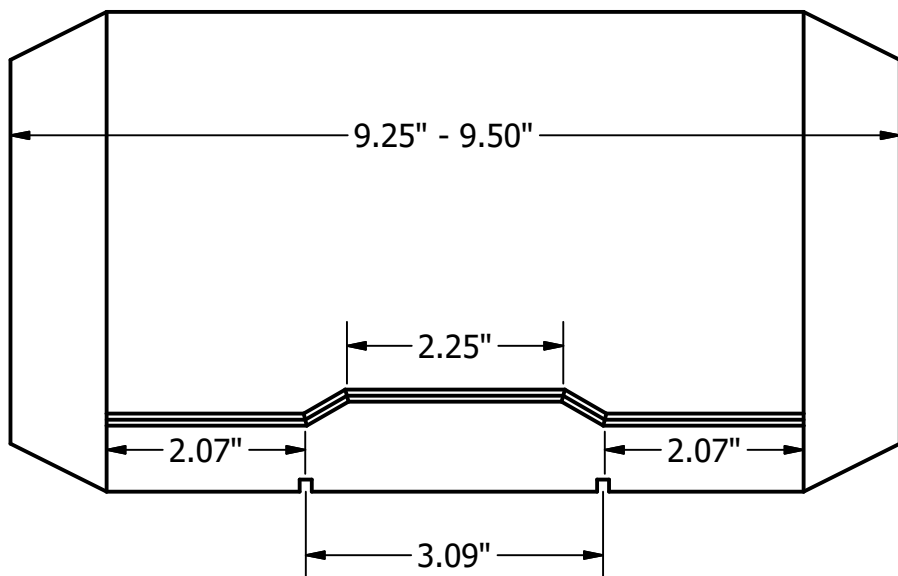

B

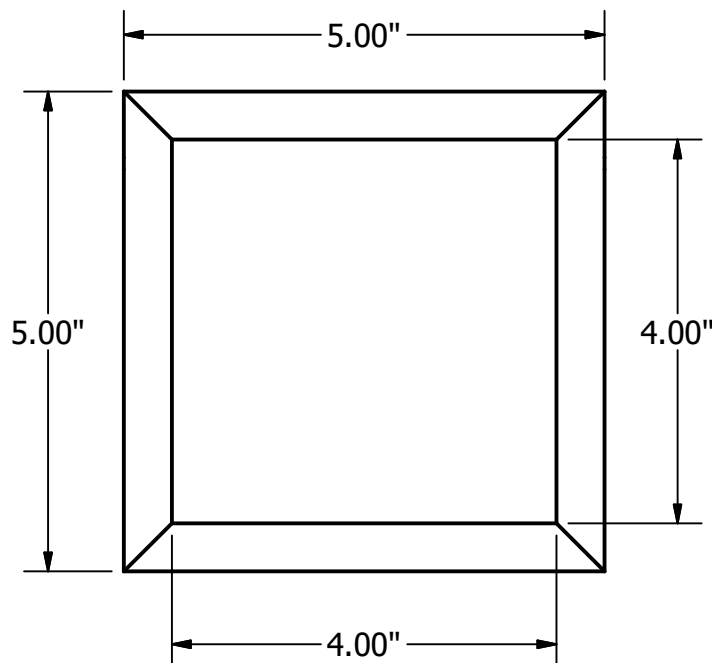

B

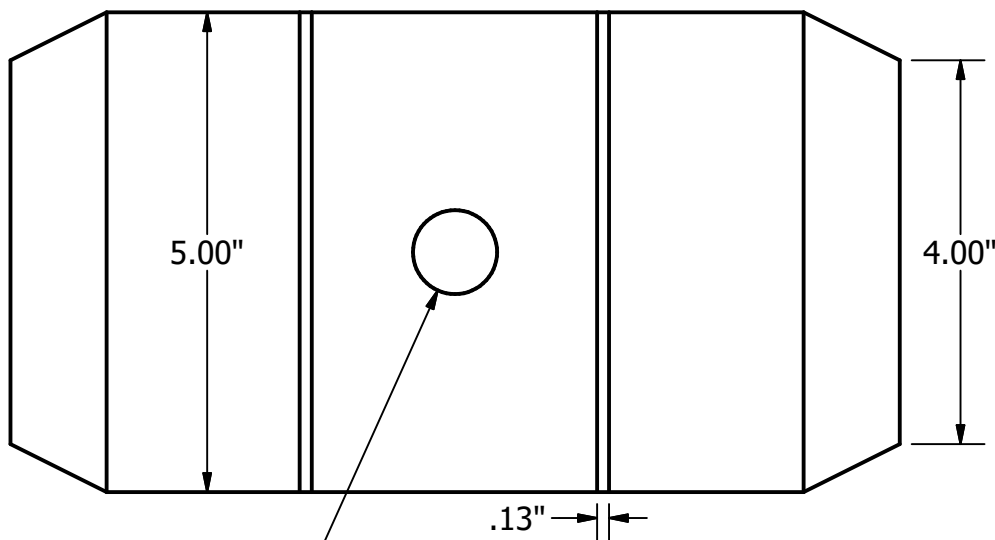

A

A

Your inside square may end up a little smaller than 4" after sanding smooth. But it will still work fine.

∅.88" or 7/8"
Make 3.5" to 4" deep

2



1

2



1

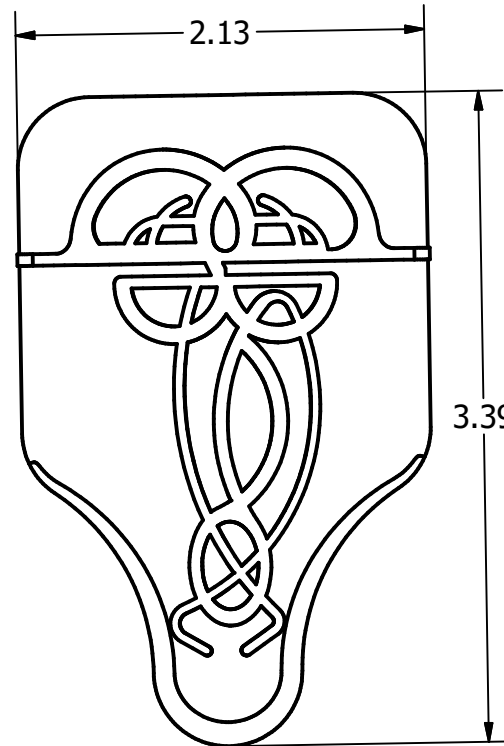
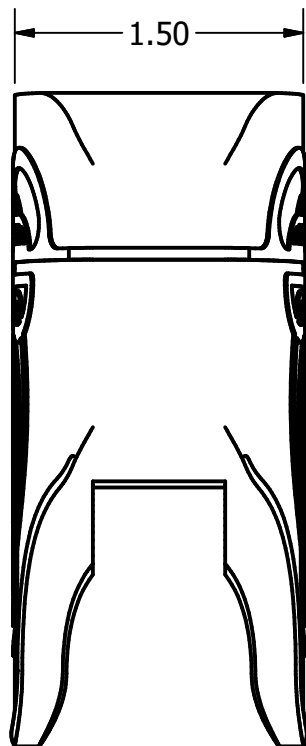
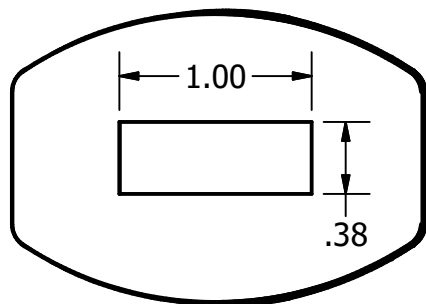

B

B

A

A

2



1

KRUMPS' PROJECTS

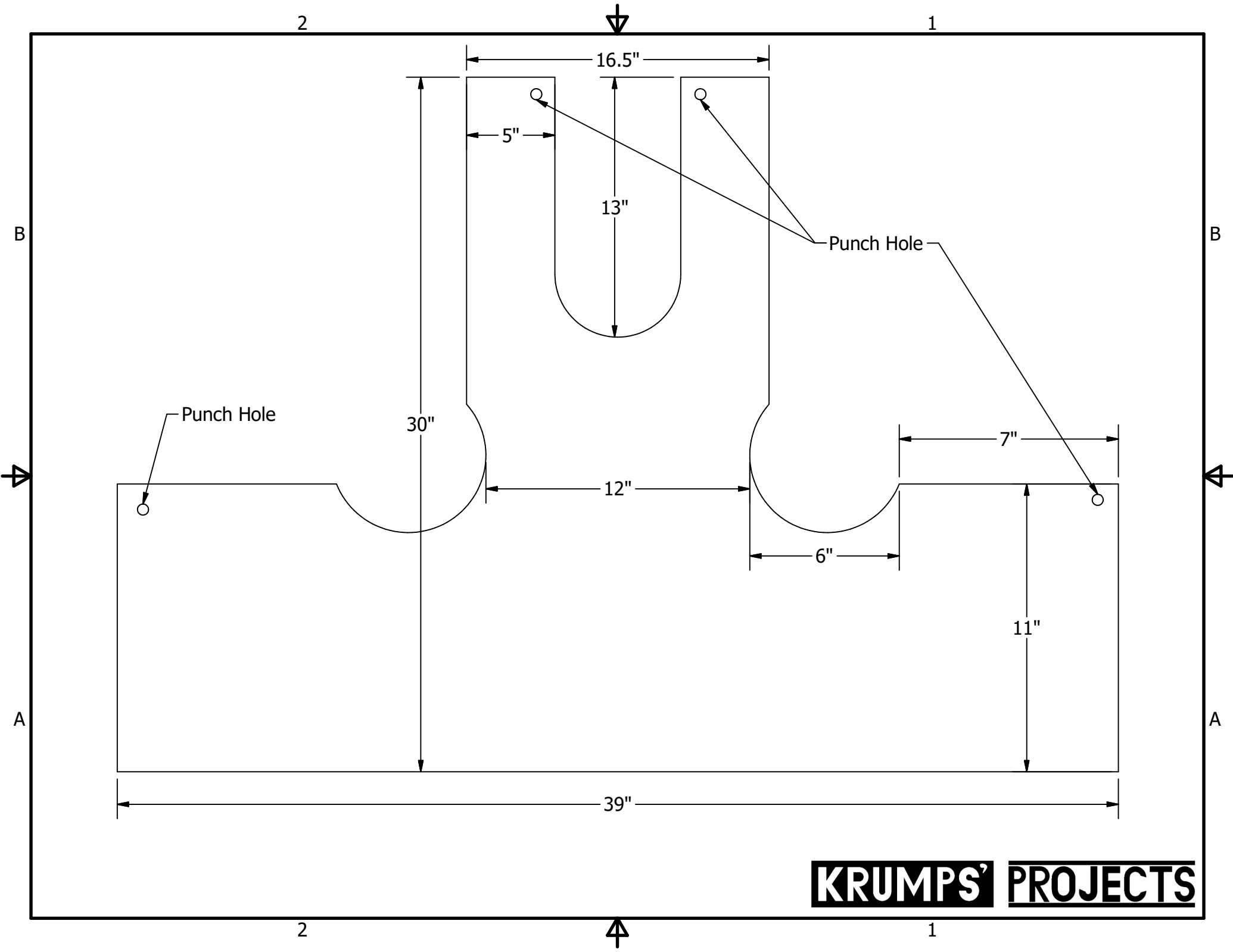

HAMMER DETAILS PRINT

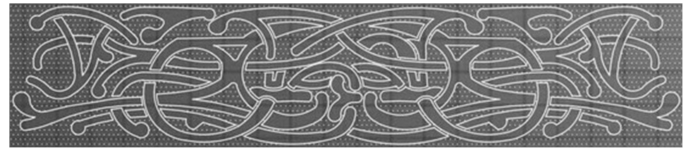
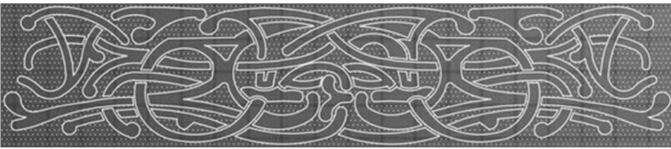
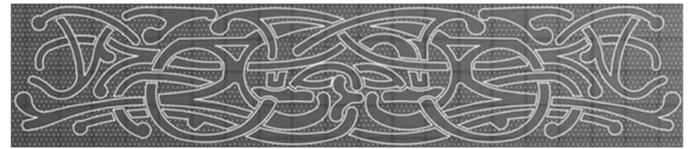
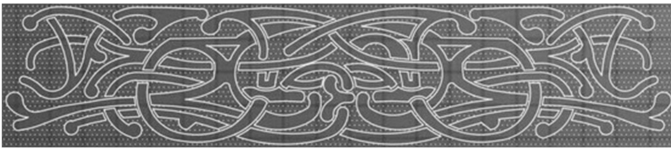
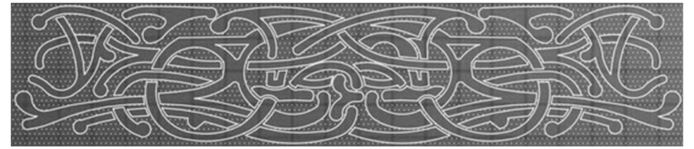
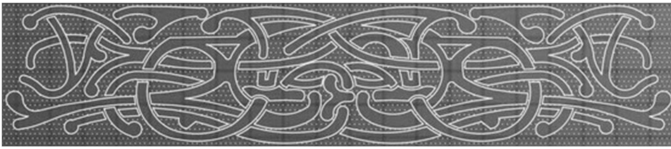
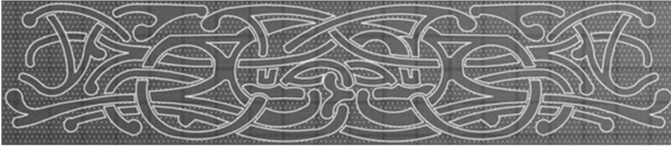

Print off this page to finish your Mjolnir

Use the emblem (right) to trace the design into the surface of the hammer head.

Use the details above to finish the chamfer edges on the hammer head. You will want to cut them out and glue them to the surface.

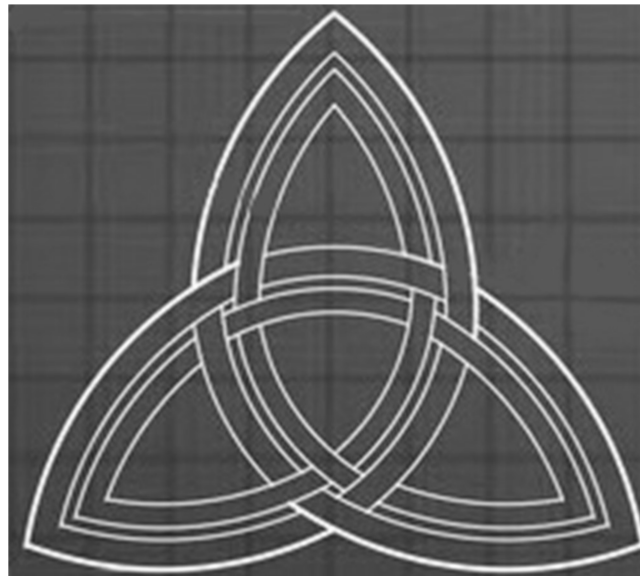

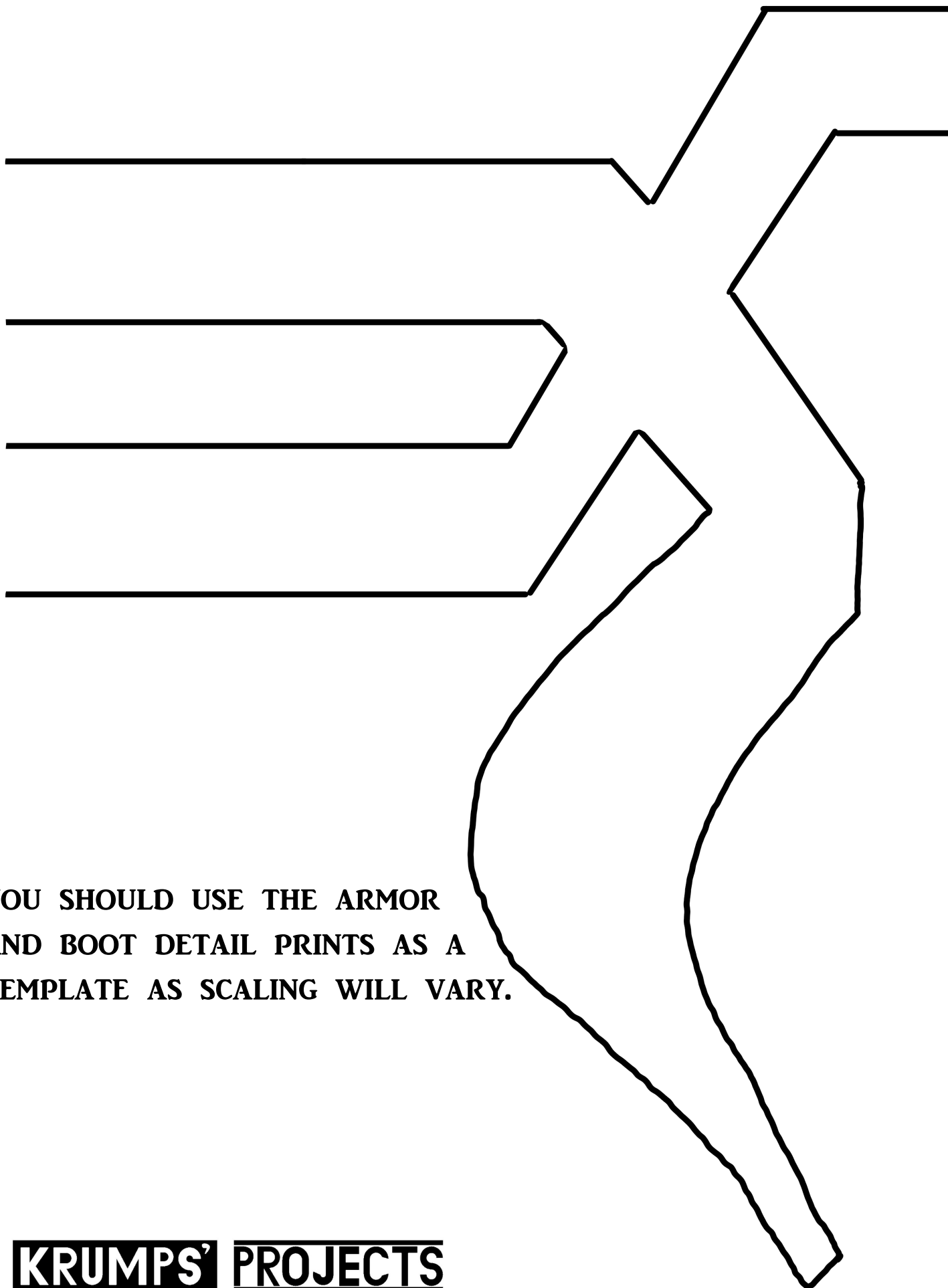

YOU SHOULD USE THE ARMOR
AND BOOT DETAIL PRINTS AS A
TEMPLATE AS SCALING WILL VARY.

KRUMPS' PROJECTS

